

Parts List

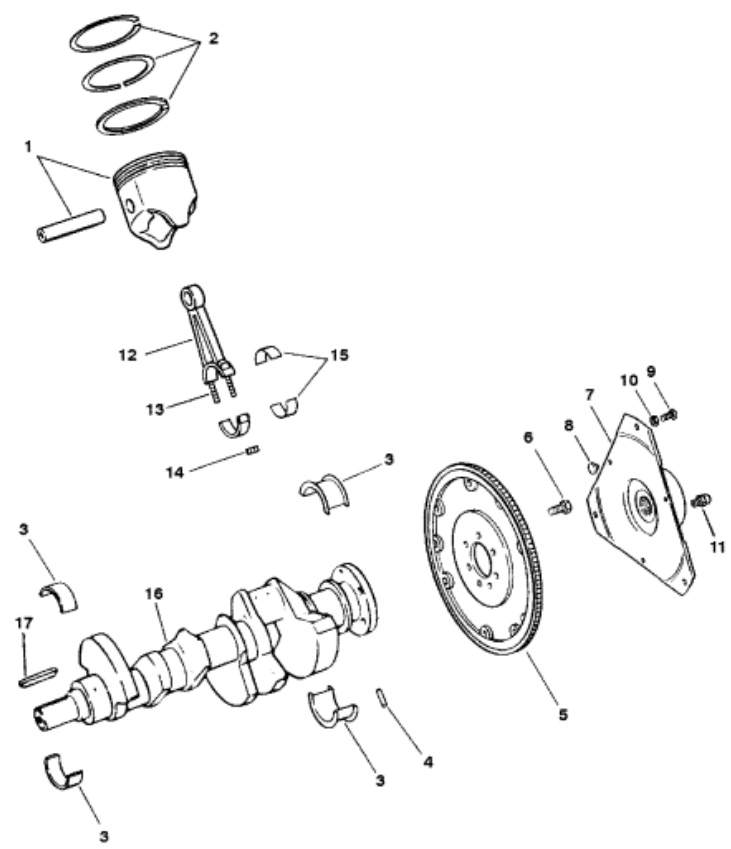

Ref	Class	Part	Description	Qty	Comment	Footnote
1	735	835001T	PISTON AND PISTON PIN	6	(STANDARD)	
1	735	835002T	PISTON AND PISTON PIN	AR	(.5MM O.S.)	4
2	39	801861T 1	RING-PISTON	6	(STANDARD)	
2	39	835000	RING-PISTON	AR	(.5MM O.S.)	4
3	23	818465	MAIN BEARING SET	1	(STANDARD)	
3	23	818466	MAIN BEARING SET	AR	(.001 U.S.)	4
3	23	818467	MAIN BEARING SET	AR	(.010 U.S.)	4
3	23	818468	MAIN BEARING SET	AR	(.020 U.S.)	4
4	17	43504	PIN-DOWEL	1		
5	222	824320 1	FLYWHEEL	1	(GM BLOCK CODE 8LK, 8LJ)	
5	222	804913	FLYWHEEL	1	(GM BLOCK CODE 9LK, 9LJ, 0LK)	
6	10	49845	SCREW	6		
7		18643A 5	COUPLING ASSEMBLY	1		
8		18644	BUMPER-RUBBER	3		
9	10	14883	SCREW (3/8-16 X 1-1/8 IN.)	3		
10	12	13510	WASHER	3		
11	22	74036	FITTING-GREASE	1		
12	614	811839T	CONNECTING ROD	6		
13	10	11969	BOLT	12		
14	11	37493	NUT	12		
15	23	11992	BEARING UNIT	6	(STANDARD - PAIR)	
15	23	11993	BEARING UNIT	AR	(.001 U.S. - PAIR)	4
15	23	811858	BEARING UNIT	AR	(.010 U.S. - PAIR)	4
15	23	811859	BEARING UNIT	AR	(.020 U.S. - PAIR)	4
16	429	9517 1	CRANKSHAFT	1	(GM BLOCK CODE 8LK, 8LJ)	
16	429	804911	CRANKSHAFT	1	(GM BLOCK CODE 9LK, 9LJ, 0LK)	
17	28	818485 1	KEY	1		